

Диаграмма состояний

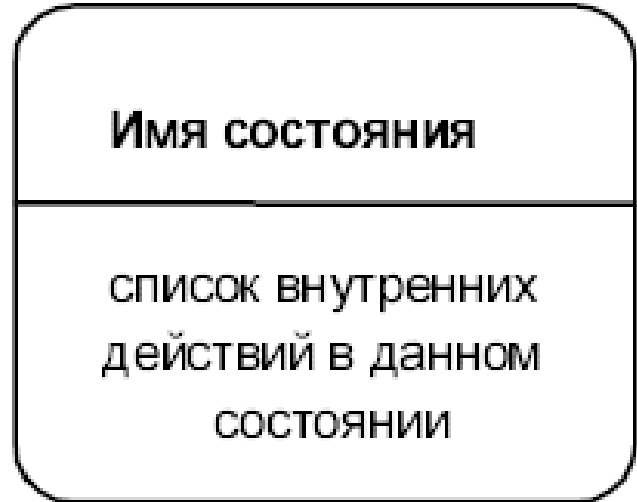

а



б

<метка действия ' / ' выражение действия>

entry
exit
do
include

Ввод пароля

entry / сделать символы
невидимыми

символ / получить символ

exit / сделать символы видимыми

<сигнатура события>
['<сторожевое условие>']
<выражение действия>

<имя события>'(<список параметров,
разделенных запятыми>')'



(а)



(б)

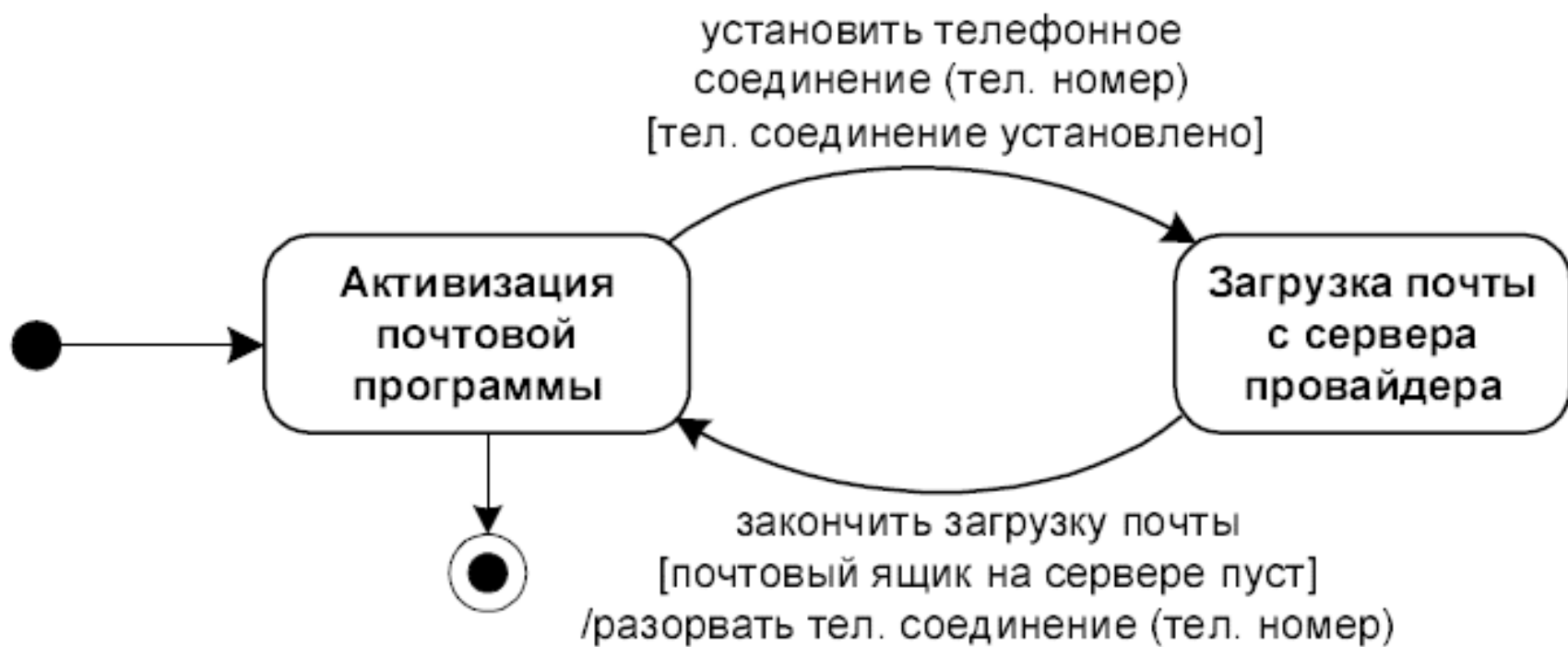

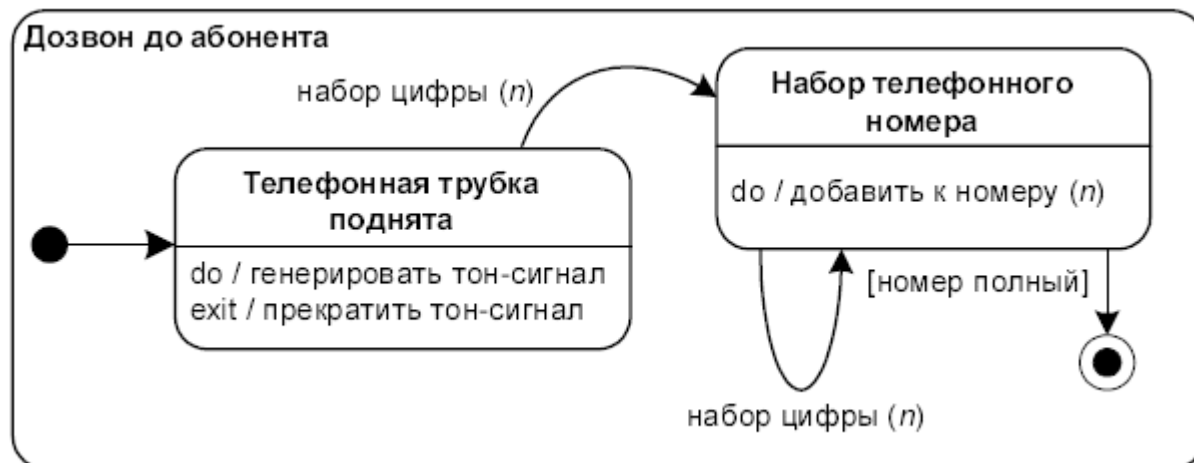
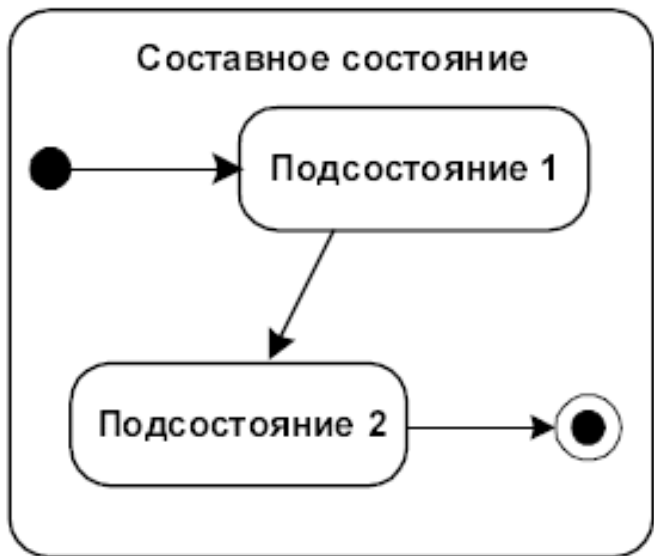

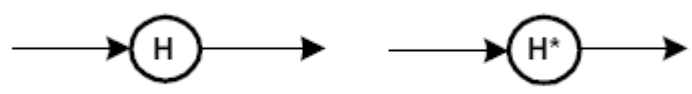
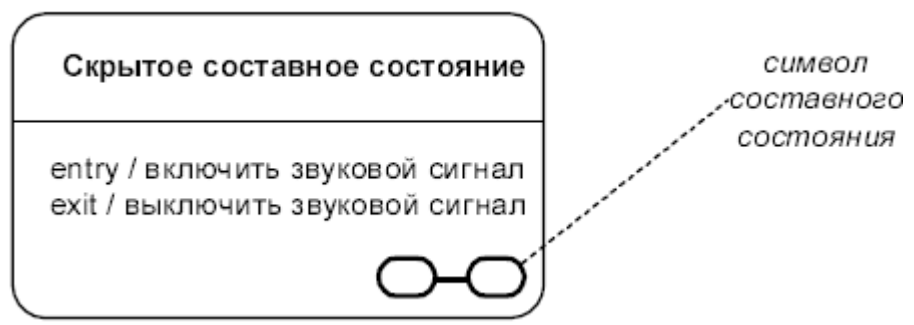
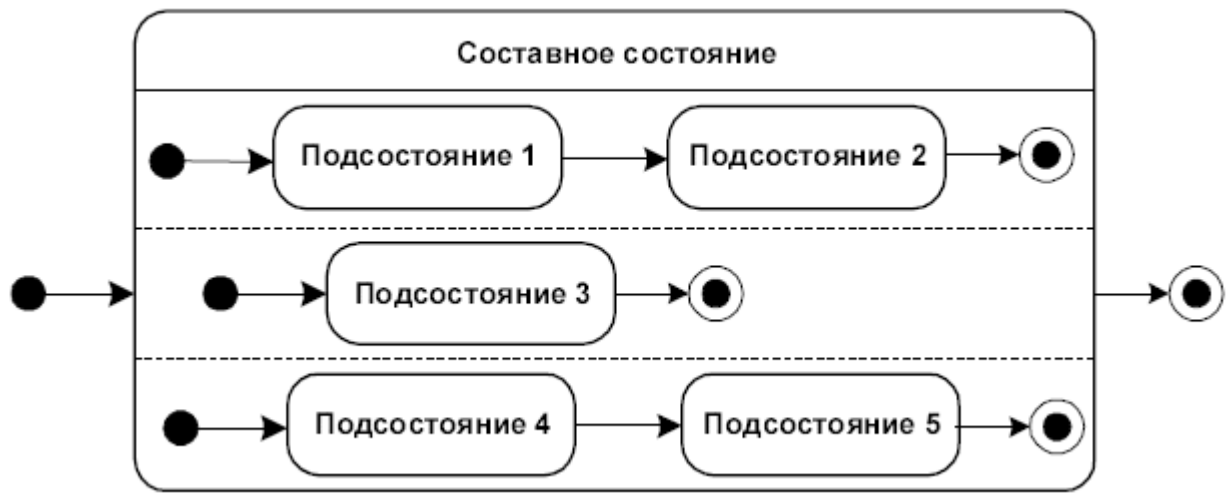

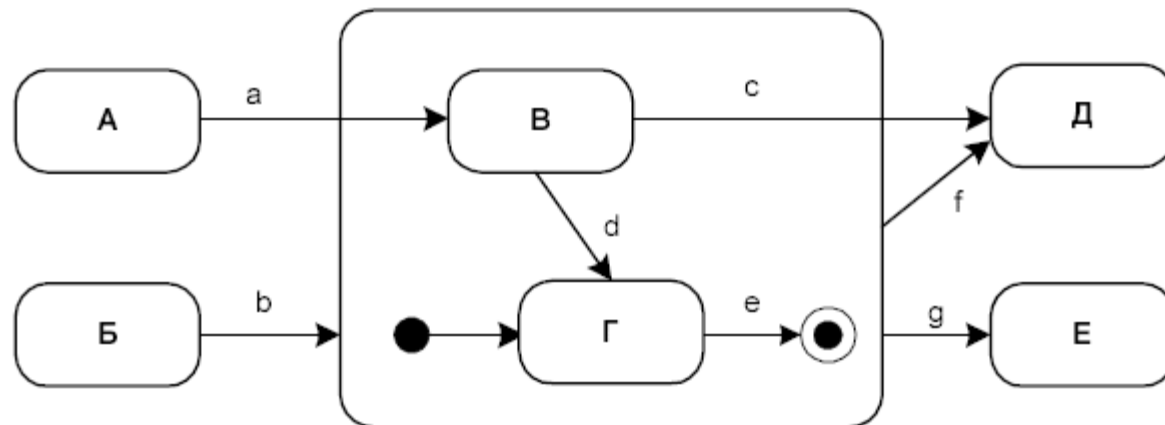
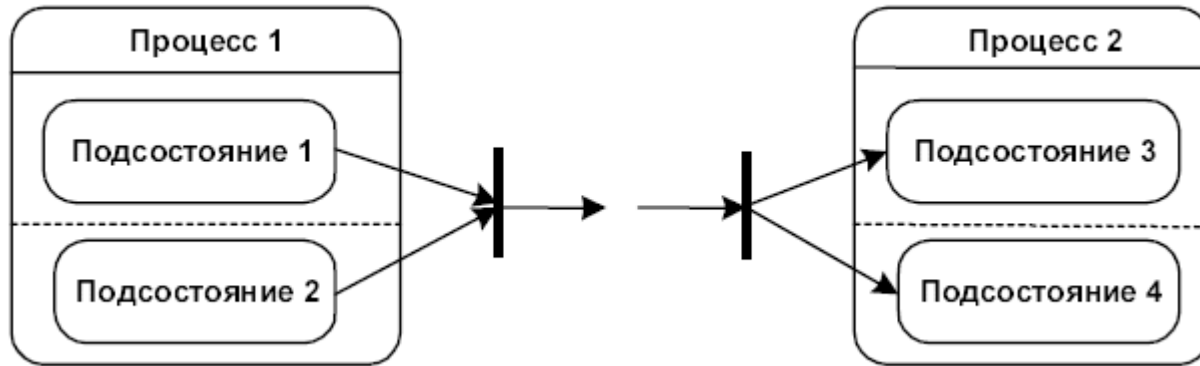

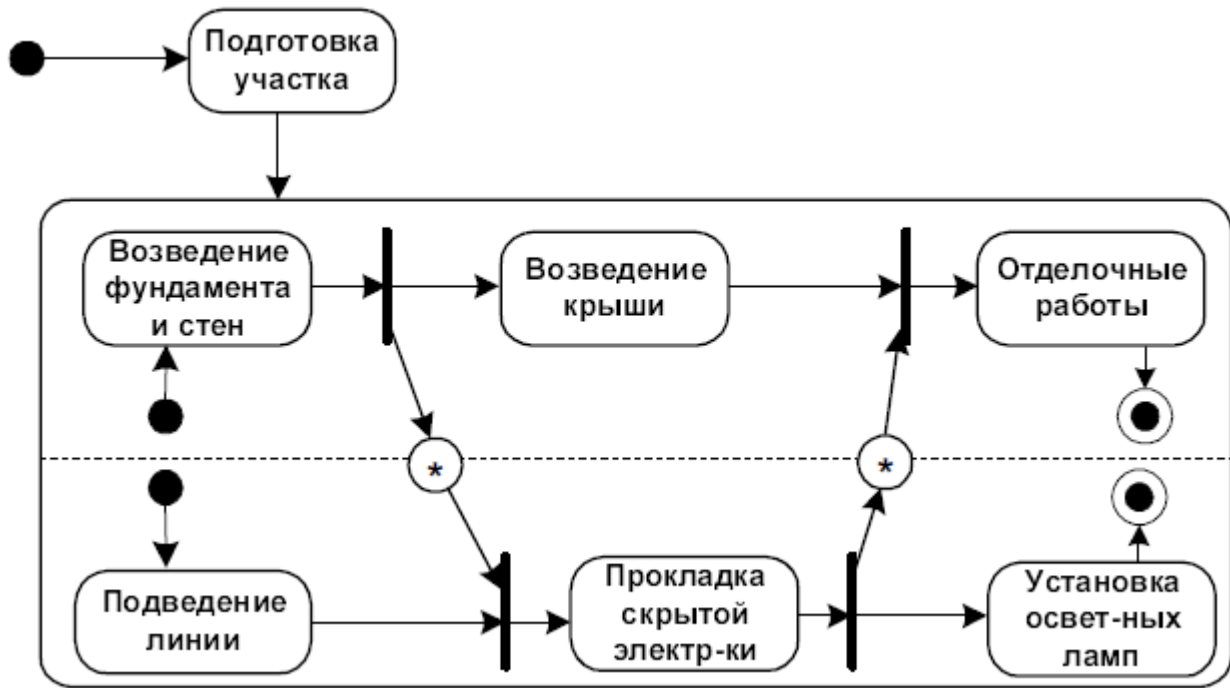

Дозвон и разговор с абонентом

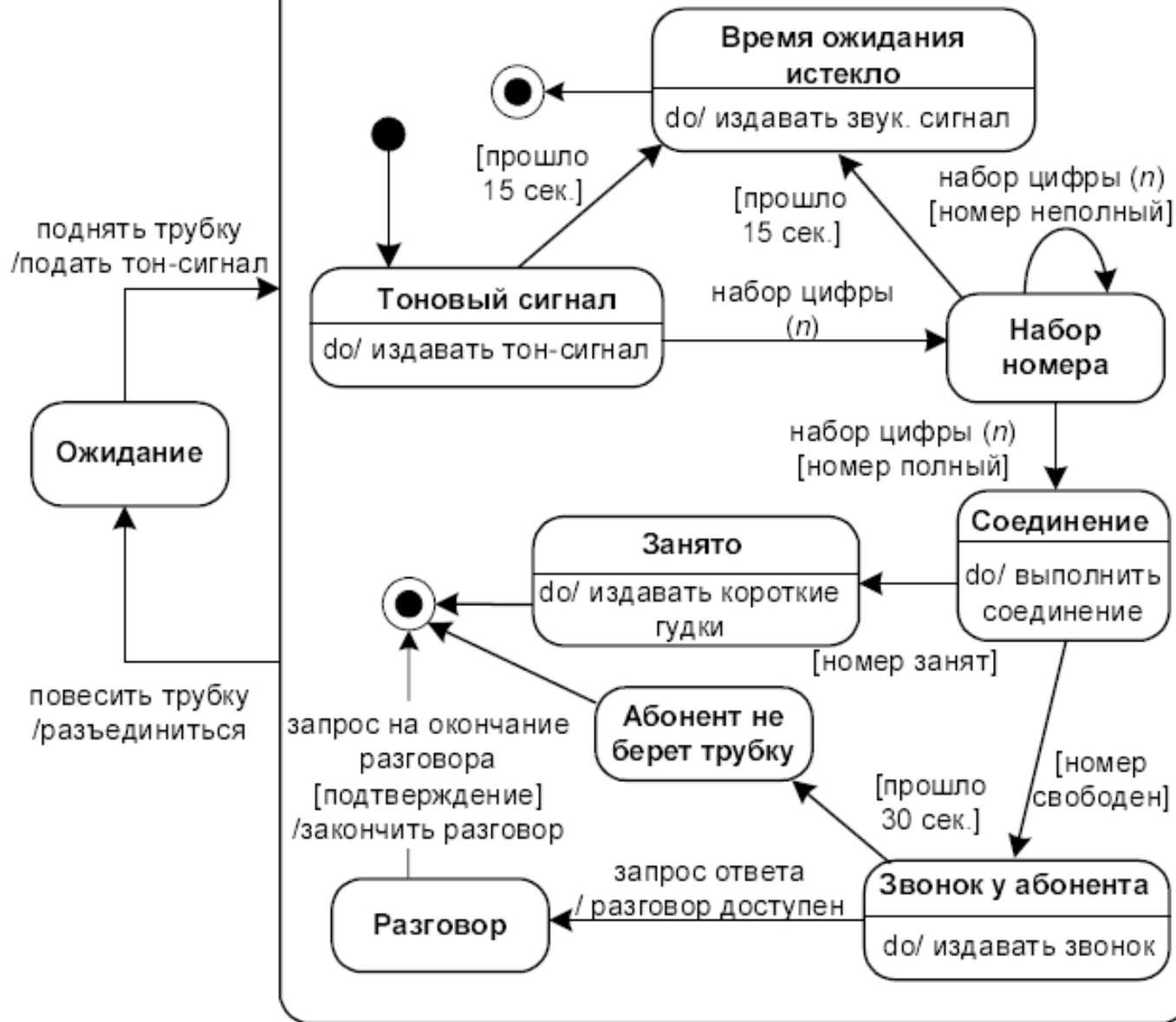



Диаграмма компонентов



Dialog.dll

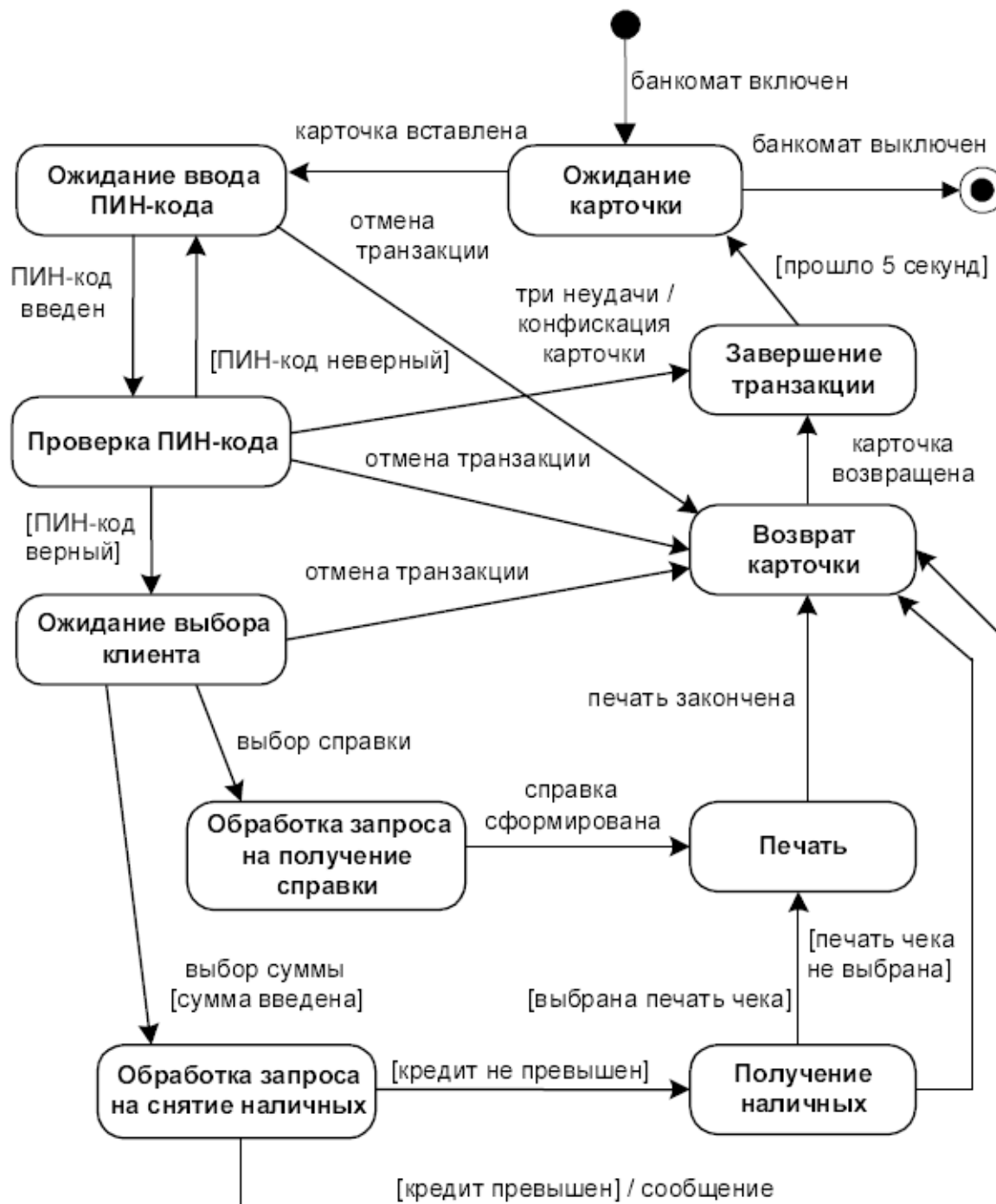
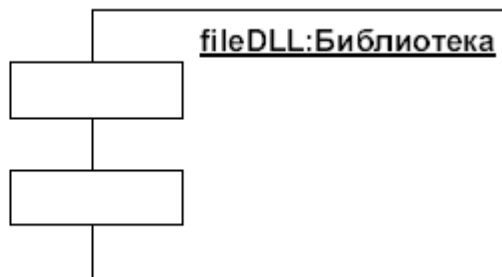
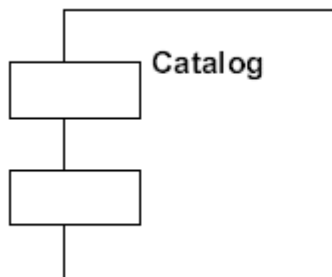
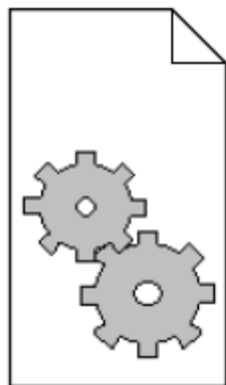

a

Index.html



б

Context .hlp

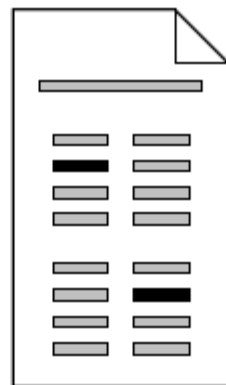

в

Main.cpp



г

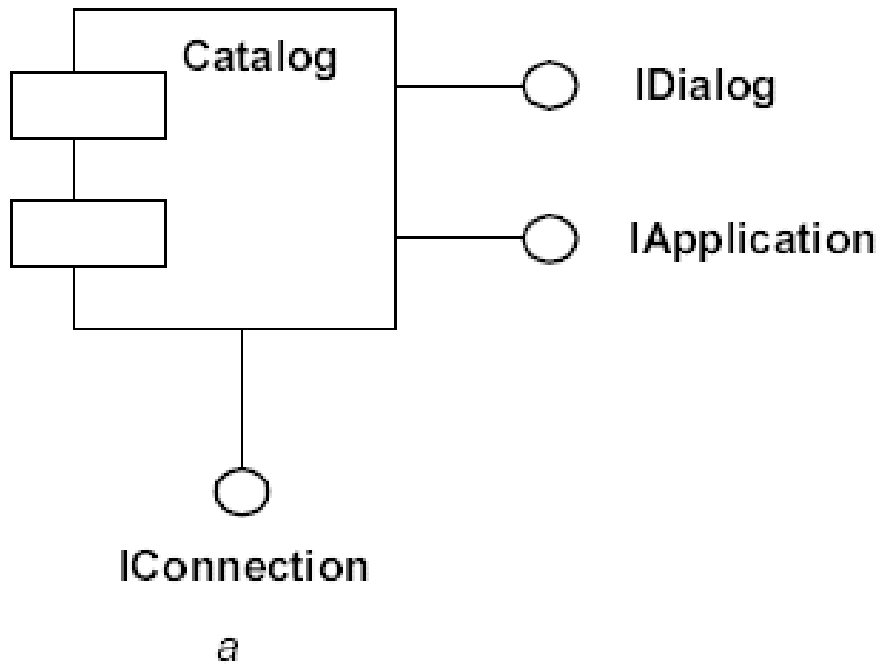

6

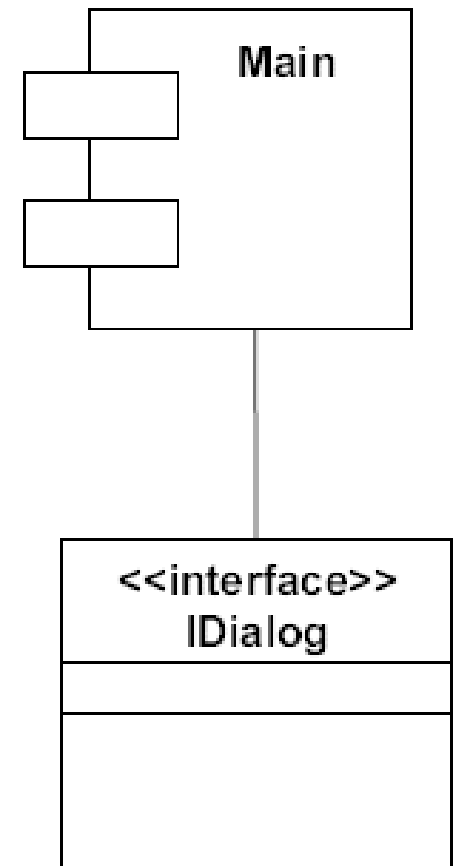

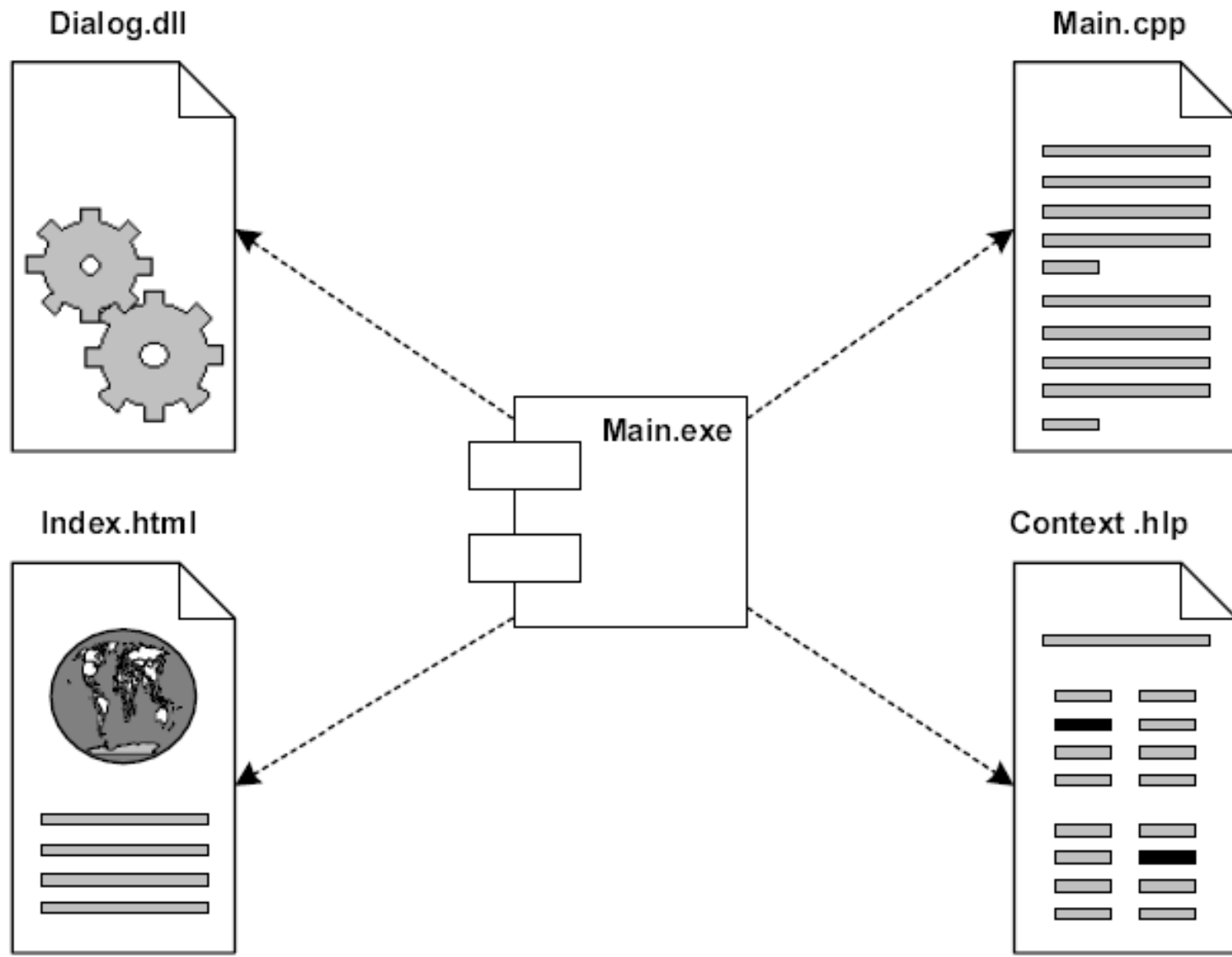

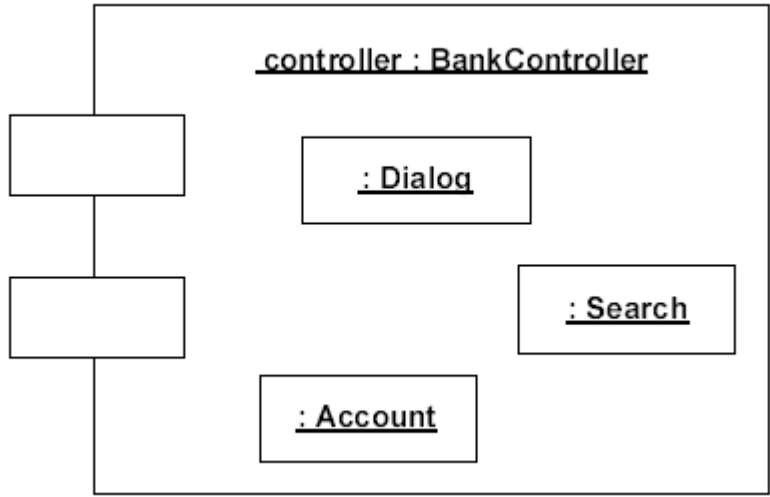
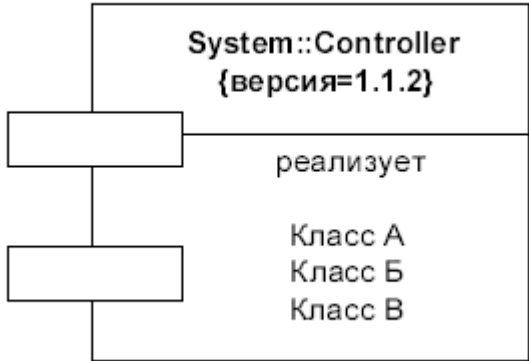



Диаграмма развертывания



а

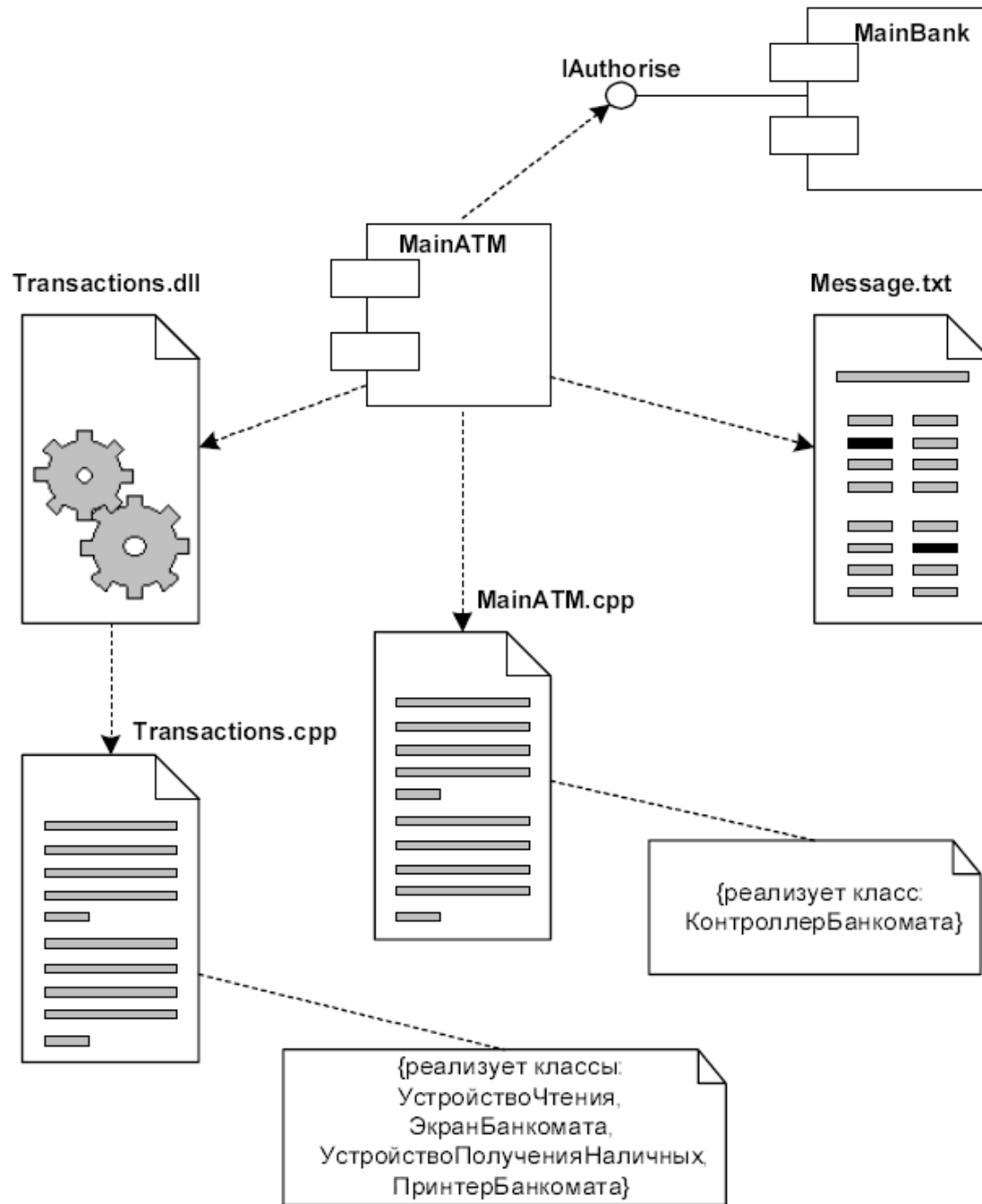
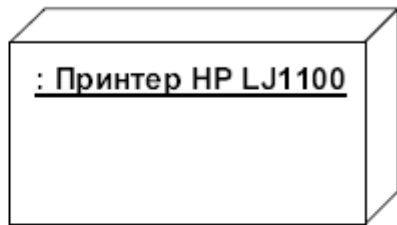

б

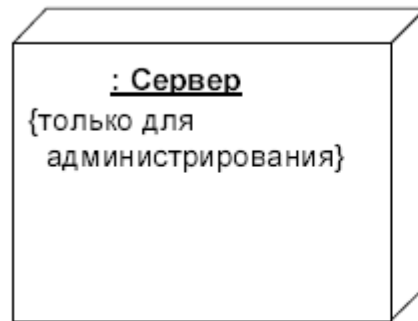

а

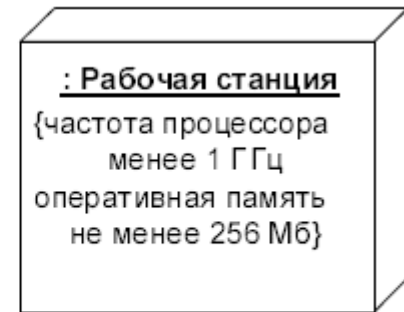

б

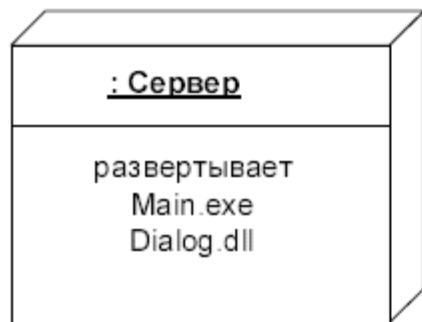

а

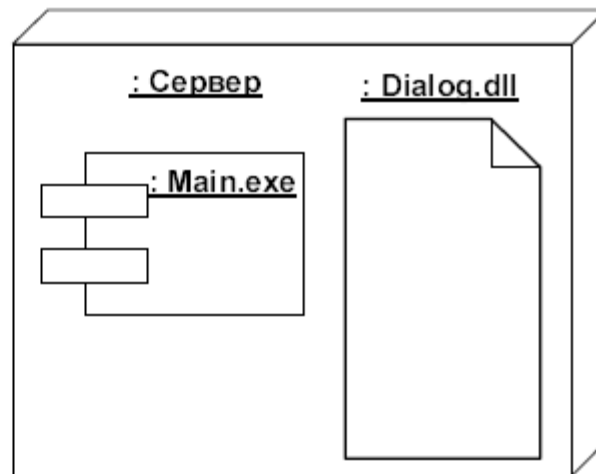

б



а

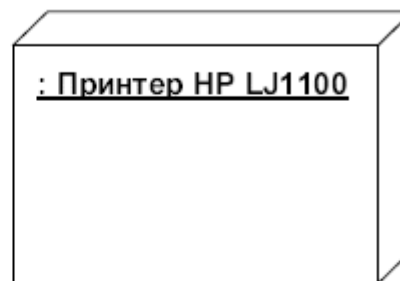

б

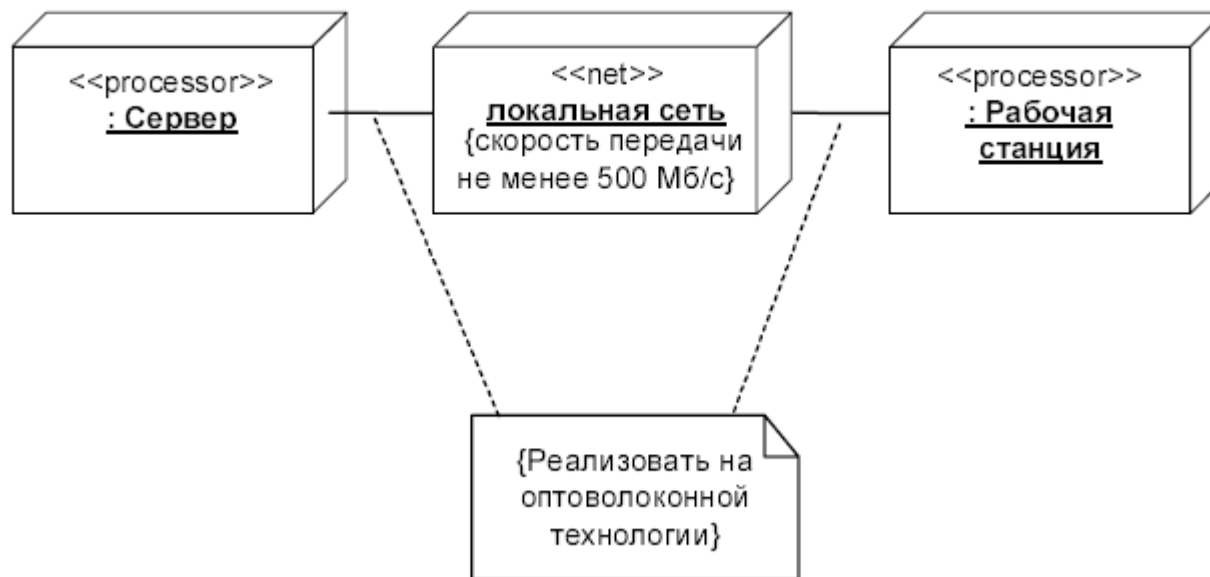

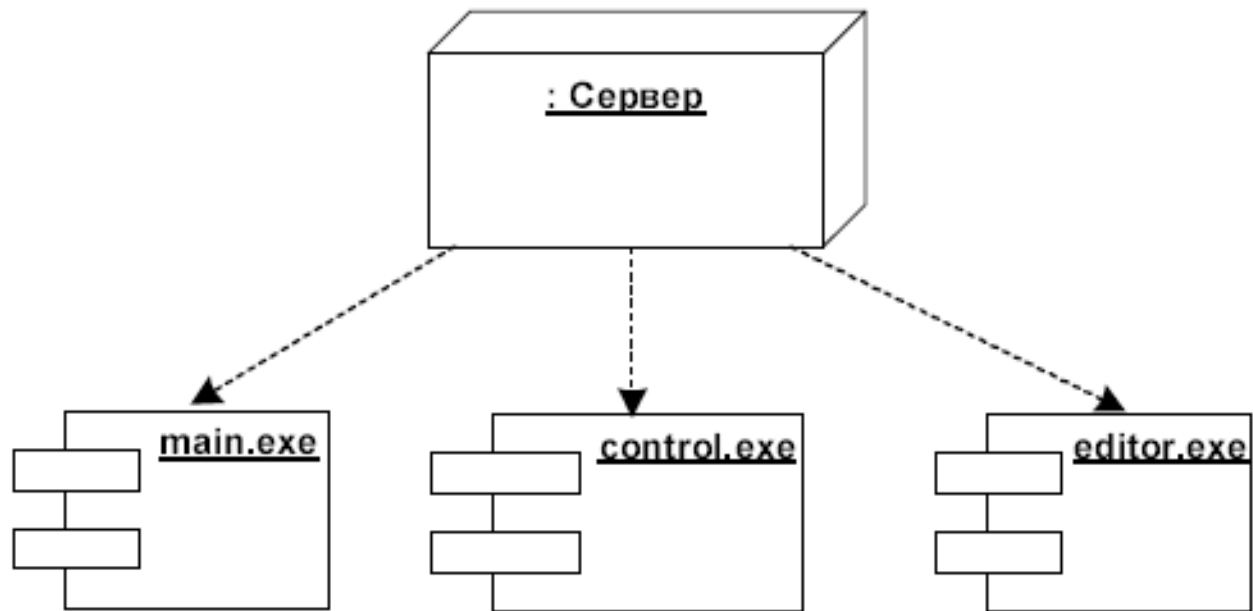

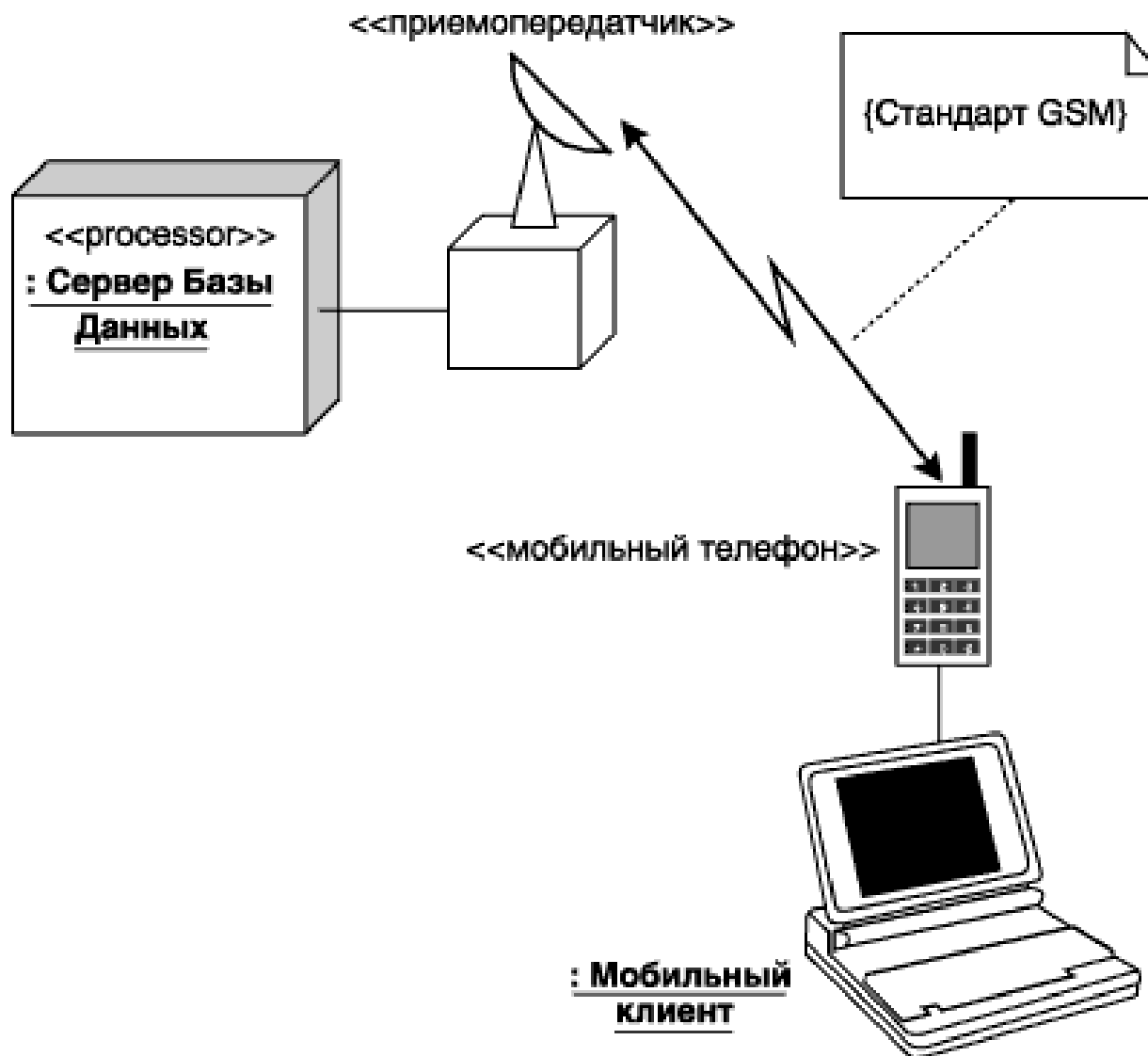

Диаграмма развертывания для системы мобильного доступа к корпоративной базе данных

